

LUBRICANTS FOR **HEAVY DUTY VEHICLES**



01 INTRODUCTION

We are a **global energy and chemical company** operating end-to-end at every stage of the oil and gas value chain. We also manufacture products from plant-based raw materials and operate in the renewable energy sector. We are committed to **minimizing the environmental impact** of our products, always seeking to reduce emissions for improved air quality.

Our more than 90 years of experience make us one of the **leading companies in the energy sector in Spain and enable us to carry out our activities on the five continents** in around twenty countries through the business areas of Exploration and Production, Refining, Chemicals, Commercial and Trading, Gas and Electricity, and Renewables. Our **technical excellence and the ability to adapt** to offer the best energy for every situation.

A team of **more than 10,000 professionals** from all over the world make this possible based on values such as **safety, sustainability, continuous improvement, leadership, and solidarity**. All this means we are a solid company that acts efficiently, adapting to a diverse energy demand and facing the challenges of the energy transition. We are present in daily life: from the electricity and transportation we use, to the heating or detergent we use in our homes.

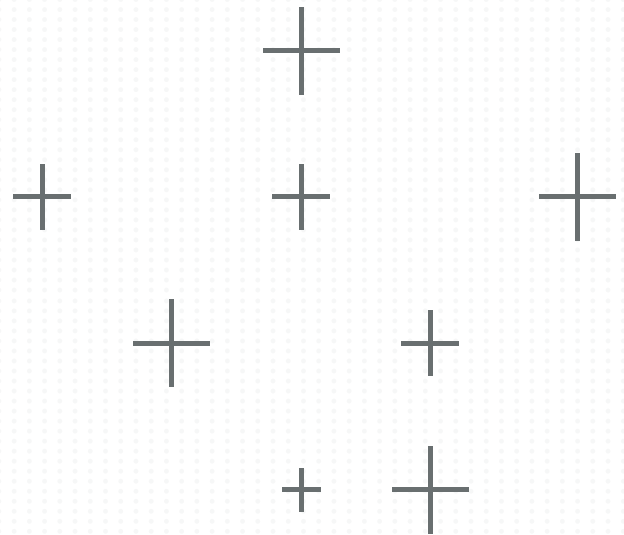

SUSTAINABILITY

We are committed to sustainability. To this end, we analyze our products' impacts on the environment throughout their life cycle with a **Life Cycle Analysis and Carbon Footprint** in order to reduce them. Only in this way can we guarantee one of our priorities: maximum environmental protection.

ETHICS

Cepsa has a commitment to **sustainable growth**, relying on ethical principles and values that strengthen our identity and enable us to carry out our work as a company with integrity and responsibility toward society. Therefore, all Cepsa professionals have the **Code of Ethics and Conduct** to guide us, where we have the principles and rules of behavior that every one of us who is a part of this team must follow.

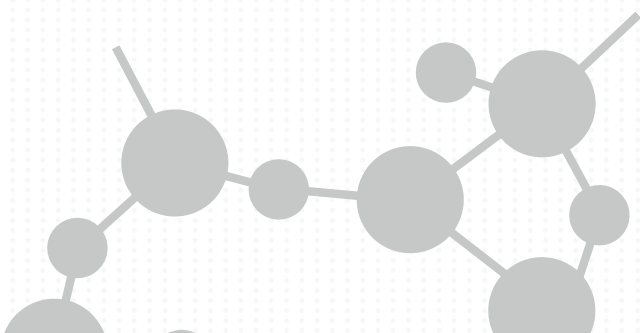

02 ENGINE LUBRICANTS

At Cepsa we have developed a **new range of lubricant products focused on heavy duty vehicle engines**, offering our customers the optimum alternative for each of their needs. Discover the new **TRACTION range of lubricants** for heavy-duty vehicles. Developed to lead the new era for your engine.



TRACTION PRO LS

Cepsa presents 100% synthetic premium quality products that meet the most stringent specifications of American and European manufacturers, providing them with a universal character.



TRACTION PRO LS 5W30

A 100% synthetic lubricant formulated with the latest additive technologies and a viscosity that promotes fuel savings of up to 1% while guaranteeing equipment protection and long drain intervals.

It has a low ash content (SAPS) designed for Euro VI and earlier engines, endorsed by the main specifications of the latest generation of European and American manufacturers that give it a universal character.

It is compatible with DPF/SCR/EGR exhaust gas after treatment systems and suitable for engines fueled by natural gas (CNG).



ACEA E6/E9/E4/E7; API CK-4; MAN M 3677/3775/3477/3271-1; MB-Approval 228.52; Volvo VDS-4.5; Renault RLD-3; Mack EOS-4.5; Scania LDF-4; Detroit Diesel DDC93K222; Cummins CES 20086; MTU Type 3.1; Deutz DQC IV-18 LA; CAT ECF-3; DAF Extended Drain; Iveco; JASO DH-2

TRACTION PRO LS 10W40

A 100% synthetic lubricant formulated with the latest additive technology. It guarantees equipment protection as well as high drain intervals.

Product with low ash content (SAPS) designed for Euro VI and earlier engines, endorsed by the main specifications of the latest generation of European and American manufacturers that provide it with a universal character.

It is compatible with DPF/SCR/EGR exhaust gas after treatment systems and suitable for engines fueled by natural gas (CNG).



ACEA E6/E9/E4/E7; API CJ-4; MAN M 3477/3575/3271-1; MB-Approval 228.51; Volvo VDS-4; Renault RLD-3; Mack EO-O Premium Plus; Scania LA; Detroit Diesel DDC93K218; Cummins CES 20081; MTU Type 3.1; Deutz DQC IV-10 LA; CAT ECF-3; JASO DH-2; VOITH Retarder Class B; MB 235.28; DAF Extended Drain; Iveco



TRACTION ADVANCED

Cepsa presents the range of high-quality lubricants that provides optimal lubrication solution suited to each engine. The products are focused on meeting all the requirements of Euro VI and earlier engines, together with the specifications of the main manufacturers.



TRACTION ADVANCED LE 5W30

A 100% synthetic low ash lubricant (SAPS) that provides extended drain intervals and fuel economy properties. Valid for the most demanding EURO VI engines that incorporate exhaust after-treatment systems (DPF/SCR/EGR), and suitable for earlier engines.

It meets the most demanding specifications of the main European and American manufacturers, and is suitable for engines that use natural gas (CNG) as fuel.



ACEA E6/E9/E7; API CK-4; MAN M 3677/3775/3477/3271-1; MB-Approval 228.52; Volvo VDS-4.5; Renault RLD-3; Mack EOS-4.5; Scania Low Ash; Detroit Diesel DDC93K222; Cummins CES 20086; MTU Type 3.1; Deutz DQC IV-18 LA; CAT ECF-3; Ford WSS-M2C213-A; Iveco 18-1804 TLS E9; DAF Extended Drain; JASO DH-2

TRACTION ADVANCED LE 10W40

A long-life lubricant formulated with synthetic technology and low ash content (SAPS). Valid for the most demanding EURO VI engines that incorporate exhaust after-treatment systems (DPF/SCR/EGR), and suitable for earlier engines.

It meets the most demanding specifications of the main European and American manufacturers, and is suitable for engines that use natural gas (CNG) as fuel.



ACEA E6/E7/E9; API CJ-4; MAN M 3477/3271-1; MB-Approval 228.51; Volvo VDS-4; Renault RLD-3; Mack EO-O Premium Plus; Scania LA; Detroit Diesel DDC93K218; Cummins CES 20081; MTU Type 3.1; Deutz DQC IV-10 LA; CAT ECF-3; JASO DH-2

TRACTION ADVANCED LE 10W30

A 100% synthetic lubricant with low ash content (SAPS), high drain interval, and fuel economy properties. Valid for the most demanding EURO VI engines that incorporate exhaust after-treatment systems (DPF/SCR/EGR), and suitable for earlier engines.

It meets the most demanding specifications of the main European and American manufacturers, and is suitable for engines that use natural gas (CNG) as fuel.



ACEA E6/E7/E9; API CK-4; MAN M 3677/3477/3271-1; MB-Approval 228.51; Volvo VDS-4; Renault RLD-3; Mack EO-O Premium Plus; Detroit Diesel DDC93K218; Cummins CES 20081; MTU Type 3.1; Deutz DQC IV-10 LA; CAT ECF-3; JASO DH-2

TRACTION ADVANCED LS 10W30

A lubricant formulated with synthetic technology and low ash content (SAPS), suitable for the most demanding European and American Euro VI and earlier engines.

A product with fuel economy properties and compatible with exhaust after-treatment systems (DPF/SCR/EGR), which meets the most demanding specifications of the main American manufacturers. Valid for road and highway engines as well as for construction machinery.



ACEA E9/E7; API CK-4; MAN M 3775/3575; MB-Approval 228.31; Volvo VDS-4.5; Renault RLD-3; Mack EOS-4.5; Detroit Diesel DDC93K222; Cummins CES 20086; MTU Type 2.1; Deutz DQC III-10 LA; CAT ECF-3; Ford WSS M2C171-F1

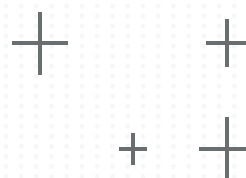

TRACTION ADVANCED LS 15W40

A lubricant formulated with Premium base oils and low ash content (SAPS), suitable for the most demanding European and American Euro VI and earlier engines.

A product compatible with exhaust after-treatment systems (DPF/SCR/EGR), meeting the most demanding specifications of the main American manufacturers.

Valid for road and highway engines as well as for construction machinery.



ACEA E9/E7; API CK-4; MAN M 3775/3575; MB-Approval 228.31; Volvo VDS-4.5; Renault RLD-3; Mack EOS-4.5; Detroit Diesel DDC93K222; Cummins CES 20086; MTU Type 2.1; Deutz DQC III-10 LA; CAT ECF-3; Ford WSS M2C171-F1

TRACTION ADVANCED LD 5W30

A 100% synthetic lubricant for European Euro V and earlier engines equipped with exhaust gas after-treatment systems (SCR/EGR) excluding the particulate filter (DPF). It provides the end user with high drain intervals, as well as fuel economy properties due to its low viscosity. It has a high detergent/dispersant power that generates a higher cleaning power compared to competitors in the market.



ACEA E4/E7; MAN M 3277; MB-Approval 228.5; Volvo VDS-3; Renault RLD-2; Mack EO-N; Scania LDF-3; Cummins CES 20077; MTU Type 3; Deutz DQC IV-10; Voith Retarder Class B; MB 235.28; DAF Extended Drain

TRACTION ADVANCED LD 10W40

A 100% synthetic lubricant with a long service life, suitable for European Euro V and earlier engines equipped with exhaust gas after-treatment systems (SCR/EGR), excluding the particulate filter (DPF), as well as for Scania Euro VI engines. It has a high detergent/dispersant power that generates a higher cleaning power compared to competitors in the market.



ACEA E4/E7; MAN M 3277; MB-Approval 228.5; Volvo VDS-3; Renault RLD-2; Mack EO-N; Scania LDF-3; Cummins CES 20072; MTU Type 3; Deutz DQC III-10; DAF Extended Drain

TRACTION ADVANCED 10W40

A 100% synthetic lubricant with a long drain interval, suitable for European Euro V and earlier engines equipped with exhaust gas after-treatment systems (SCR/EGR) excluding the particulate filter (DPF).



ACEA E4/E7; API CI-4; MAN M 3377/3277; MB-Approval 228.5; Volvo VDS-3; Renault RLD-2; Mack EO-N; Detroit Diesel DDC93K215; Cummins CES 20078; MTU Type 3; Deutz DQC IV-10; Global DHD-1

TRACTION MAX

Cepsa offers the TRACTION MAX range for the EURO V and earlier engines that are not equipped with a DPF after-treatment system and are regulated by the ACEA categories currently in force. The products have been reformulated to meet the higher oxidation requirements required of products categorized as ACEA E7.



TRACTION MAX 10W40

A lubricant formulated with synthetic technology, valid for Euro V and earlier engines with EGR and SCR but not equipped with DPF.

Recommended for mixed fleets, it protects the engine under the most severe service conditions: transport, construction, quarries, and more.



ACEA E7; API CI-4; MAN M 3275-1; MB-Approval 228.3; Volvo VDS-3; Renault RLD-2; Mack EO-N; Detroit Diesel DDC93K215; Cummins CES 20078; MTU Type 2; Deutz DQC III-10; CAT ECF-2; JASO DH-1; GLOBAL DHD-1

TRACTION MAX 15W40

Lubricant formulated with Premium base oils, valid for Euro V and earlier engines with EGR and SCR but not equipped with DPF.

It provides excellent engine protection in buses, trucks and construction machinery from European and American manufacturers.



ACEA E7; API CI-4; MAN M 3275-1; MB-Approval 228.3; Volvo VDS-3; Renault RLD-2; Mack EO-N; Detroit Diesel DDC93K215; Cummins CES 20078; MTU Type 2; Deutz DQC III-10; CAT ECF-2; JASO DH-1; GLOBAL DHD-1

TRACTION MAX 20W50

A mineral lubricant suitable for use in Euro IV and earlier engines, not equipped with DPF.

A product for all types of heavy vehicles and vans in urban and interurban service. Especially for construction and mining machinery.

- API CH-4; MAN M 3275-1; MB 228.3; Volvo VDS-2; Renault RD-2; Mack EO-M Plus; Cummins CES 20077; MTU Type 2; Deutz DQC II-05; CAT ECF-1a



TRACTION

Cepsa offers this line of products for the lubrication of EURO IV and earlier engines whose technical requirements are less stringent.



TRACTION 15W40

A mineral lubricant for the lubrication of EURO III and earlier engines (without DPF) operating in urban and interurban service, with a high presence of dust and pollutants in the air.

A product that provides standard drain intervals and optimal detergency and dispersancy in the engine.

- ACEA E2; MAN M 271; MB 228.1; Volvo VDS; Mack EO-M; Cummins CES 20076; MTU Type 1; CAT ECF-1st



TRACTION 25W60

A high performance and high viscosity mineral lubricant, intended for engines with high demands for use in hot climates or high mileage that result in play causing high oil consumption.

- API CF/SF; CCMC D2; CAT TO-2; ALLISON C3

TRACTION SAE 30-40-50-60

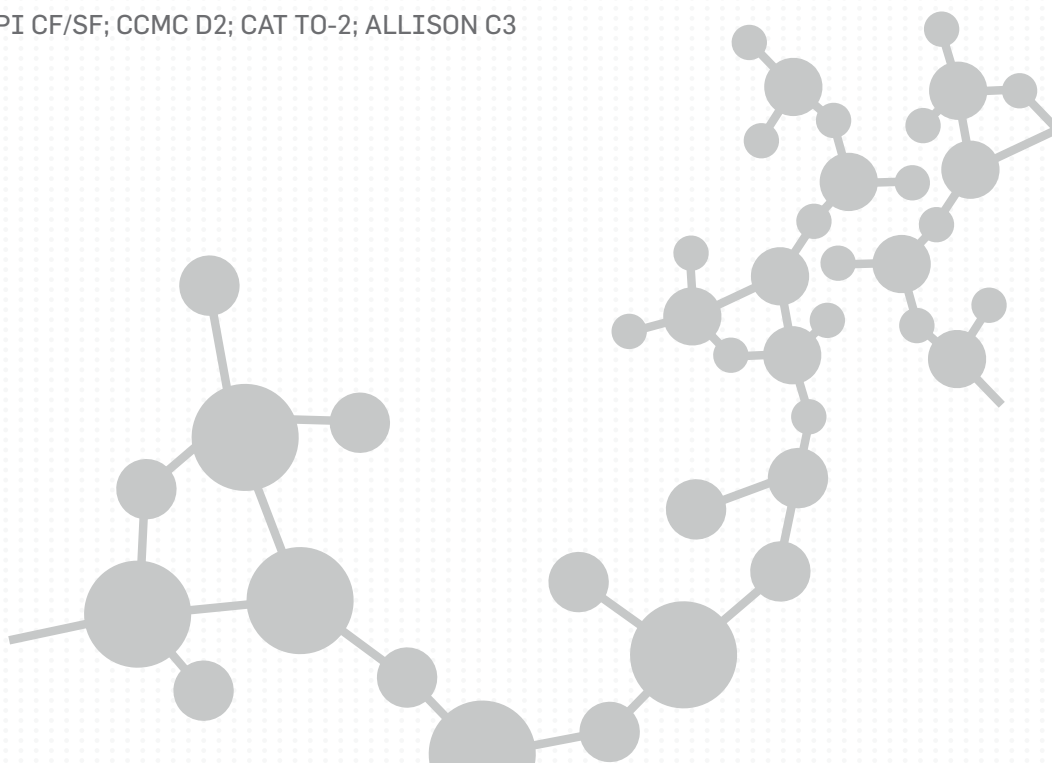

High-performance monograde mineral lubricant, formulated with very high quality conventional base oils and additives. Effective control of deposits and wear.

- API CF/SF; CCMC D2; CAT TO-2; ALLISON C3



03 TRANSMISSION LUBRICANTS

PRODUCT	USES	SPECIFICATIONS	DESCRIPTION
ATF 4000 S 	Automatic transmissions	<ul style="list-style-type: none"> •Voith 150.014524.xx •ZF TE-ML 14C/20C •MAN 339 Type Z3/Z12/V2 •MB-Approval 236.9 •VOLVO 97341 	<p>High quality 100% synthetic lubricant for automatic transmissions operating in very severe conditions and long drain interval.</p> <p>It is also suitable for use in servo transmissions and industrial hydraulic systems.</p>
ATF 3000 S 	Automatic transmissions	<ul style="list-style-type: none"> •G. Motors DIII-H •ZF TE-ML 03D/04D/14B/17C/20B/25B - ZF000386 -Voith 55.6336.xx •MB-Approval 236.9 •Ford MERCON V •VOLVO 97341 •ALLISON TES-295 •ALLISON C-4 •MAN 339 Type Z2/V2/Z11 	<p>High quality synthetic oil for automatic transmissions operating under severe conditions. It is also suitable for use in servo transmissions and industrial hydraulic systems.</p>
ATF 2000 S 	Automatic transmissions	<ul style="list-style-type: none"> •G. Motors DIII-H/G •ZF TE-ML 03D/04D/14A/17C - ZF000670 •VOITH 55.6335.xx (ex G-607) •MB-Approval 236.9 •VOLVO 97341 •Ford MERCON •CAT TO-2 (Nivel) •MAN 339 Type Z1/V1/L1 •ALLISON C-4 	<p>Semi-synthetic oil for automatic and servo-transmissions in accordance with to the demands by European and American vehicles and transmissions.</p> <p>Specially designed for those applications where the manufacturer recommends a G. Motors DIII-H or DIII-G fluid.</p>
ATF 70	Automatic transmissions	<ul style="list-style-type: none"> •G. Motors DII-D •ZF TE ML 04D/14A ZP - ZF00193921 •VOITH 55.6335.xx (ex G-607) •MB-Approval 236.9 •ALLISON C-4 •CAT TO-2 •MAN 339 V1/Z1 •GM Type A Suffix A 	<p>Lubricating oil manufactured with specially selected bases and a powerful additive package for use in gearboxes requiring General Motors DII-D specification.</p>
CEPSA TRANSMISIONES Z5 FE+LD 75W80 	Manual transmissions	<ul style="list-style-type: none"> •API GL-4 •ZF TE-ML 01E/02E/16P - ZF 00240 •MAN 341 Type Z5 •MB 235.28 	<p>100% synthetic universal multigrade lubricating oil developed for manual latest-generation gearboxes operating in harsh conditions, with high loads and high temperatures.</p> <p>The product is formulated with high-quality technology that provides very long oil-change periods in the equipment where it is used as well as fuel-saving properties.</p>

PRODUCT	USES	SPECIFICATIONS	DESCRIPTION
CEPSA TRANSM. FE+LD 75W80 	Manual transmissions	<ul style="list-style-type: none"> •API GL-4 •ZF TE-ML 01L/02L/16K – ZF 000472 •Renault / DAF / IVECO •MIL-PRF-2105 •VOLVO 97307 •EATON Europe (300.000 km or 3 years) •MAN 341 Z-4 	High-performance synthetic lubricating oil for latest generation heavily loaded manual gearboxes. Due to the exceptional qualities of its components, it is recommended for extended drain intervals and as a “fuel economizer” oil.
CEPSA TRANSMISIONES MBT 75W90 	Manual transmissions	<ul style="list-style-type: none"> •API GL-4 •MB-Approval 235.11 	High-performance 100% synthetic lubricating oil for manual gearboxes specially developed for Mercedes Benz ACTROS vehicles. Due to the exceptional qualities of its components, it is recommended for extended drain intervals and as a “fuel economizer” oil.
CEPSA TRANSMISIONES 80W90	Manual transmissions	<ul style="list-style-type: none"> •API GL-4 •ZF TE-ML 16A/17A/19A - ZF 000023 •MAN 341 E1/ Z2 •MB 235.1 	Mineral lubricant, manufactured with high quality hydrogenated bases, developed to lubricate gears in automotive transmissions (gearboxes, differentials, final control axles).
CEPSA TRANSM. EP FE+LD 75W90 	Axles and differentials	<ul style="list-style-type: none"> •API GL-5 / GL-4 / MT-1 •MIL-PRF-2105E (SAE J2360 approval) •ZF TE-ML 02B/05A/12L/12N/16F/17B/19C/21A - ZF000086 •MAN 341 Type Z2 •MAN 342 S1 •SCANIA STO 1:0 box •Eaton Long Drain (300.000 Km.) •MB-Approval 235.8 	100% synthetic universal multi-grade extreme pressure lubricant oil (EP) for the rear axles which require a more effective oil in duration and friction than traditional oils used for this application. Specially recommended to improve the performance of SAE 80W-90 EP due to its wider temperature range.
CEPSA TRANSMISIONES EP 80W90/85W140	Axles and differentials	<ul style="list-style-type: none"> •API GL-5 •ZF TE-ML 05A/12E/16B/17B/19B - ZF000084 (80W-90) •ZF TE-ML 05A/12E/16D21A - ZF000085 (85W-140) •MIL-L-2105-D •MAN 342 Type M2 (80W90) 	Mineral lubricant formulated for the lubrication of manual transmissions and automotive gear, where extreme pressure (EP), good flowing at low temperatures and a viscosity allowing high-load support and shock impact are required.

PRODUCT	USES	SPECIFICATIONS	DESCRIPTION
CEPSA TRANSMISIONES EP 90	Axles and differentials	<ul style="list-style-type: none"> •API GL-5 •MIL-PRF-2105-E •ZF TE-ML 16C/17B/19B/21A - ZF000097 •MB-Approval 235.0 •MAN 342 Type M1 •Volvo 97310 	Mineral lubricant for the lubrication of manual gearboxes, differentials and, in general, automotive transmission gears requiring extreme pressure (EP) properties.
CEPSA AURIGA LS PLUS 80W90	Agricultural/ Construction	<ul style="list-style-type: none"> •API GL-5 •MIL-PRF-2105 •ZF TE-ML 05C/12C/21C ZP -ZF001050 	Lubricant specially formulated to lubricate differentials where oils with limited slip characteristics are required.
CEPSA AURIGA TE 85	Agricultural/ Construction	<ul style="list-style-type: none"> •API GL-4 •MF M1135 •FORD M2C 86 B 	UTTO oil formulated to meet the requirements of FORD M2C 86B specification for hydraulic systems and oil immersed brakes. Meets MASSEY FERGUSON MF 1135 specification.
CEPSA AURIGA TE 55 10W30	Agricultural/ Construction	<ul style="list-style-type: none"> •API GL-4 •ALLISON C3C4 •CAT TO-2 •MF M1145/1143/ 1141/1135 •ZF TE-ML 03E/05F 17E/21F •VOLVO 97303 (WB 101) •CHN MAT 3525 •FNHA-2C-201.00 (FORD M2C-134D) •KUBOTA UDT 	UTTO oil formulated to meet the requirements of modern agricultural equipment. Suitable for use in wet brakes, hydraulic systems, clutches and torque converters.
CEPSA AURIGA TA 40	Agricultural/ Construction	<ul style="list-style-type: none"> •SAE 10W •ALLISON C3 •CATERPILLAR TO-2 	CEPSA AURIGA TA-40 oil is specially formulated for use in torque converters and hydraulic transmissions that require a fluid of this nature.

PRODUCT	USES	SPECIFICATIONS	DESCRIPTION
CEPSA TRANSMISIONES TO-4 SAE 10	Construction	<ul style="list-style-type: none"> •CAT TO-4 •ALLISON C-4 •KOMATSU MICRO CLUTCH 	Lubricant especially recommended for transmissions, torque converters, transfer cases and final control axles.
CEPSA TRANSMISIONES TO-4 SAE 30	Construction	<ul style="list-style-type: none"> •CAT TO-4 •ALLISON C-4 •KOMATSU MICRO CLUTCH 	Lubricant especially recommended for transmissions, torque converters, transfer cases and final control axles.
CEPSA TRANSMISIONES TO-4 SAE 50	Construction	<ul style="list-style-type: none"> •CAT TO-4 •ALLISON C-4 •KOMATSU MICRO CLUTCH 	Lubricant especially recommended for transmissions, torque converters, transfer cases and final control axles.
CEPSA TRANSMISIONES FD1 SAE 60	Construction	<ul style="list-style-type: none"> •CAT FD-1 	<p>Lubricant oil especially recommended for differential and final control axles that require the CATERPILLAR FD-1 specification, which does not contain friction material (at least as specified) and work in extremely high load situations and in applications where high working temperatures require the use of such an oil.</p> <p>This oil is not recommended for use in engines, transmissions or hydraulic systems.</p>

04 RECOMMENDED LUBRICANTS FOR EACH LUBRICATION POINT

ENGINE'S SUMP

TRACTION PRO LS 5W30
TRACTION PRO LS 10W40
TRACTION ADVANCED LE 5W30
TRACTION ADVANCED LE 10W40
TRACTION ADVANCED LE 10W30
TRACTION ADVANCED LS 10W30
TRACTION ADVANCED LS 15W40
TRACTION ADVANCED LD 10W40
TRACTION MAX 10W40
TRACTION MAX 15W40

DIFFERENTIALS AND AXLES

TRANSMISIONES EP FE+LD 75W90
TRANSMISIONES EP 80W90
TRANSMISIONES EP 90
TRANSMISIONES EP 85W140

LUBRICATION POINTS

CEPSA ARGA COMPLEX LITIO EP
CEPSA ARGA LITIO 2 MOLY
CEPSA ARGA LITIO EP-2

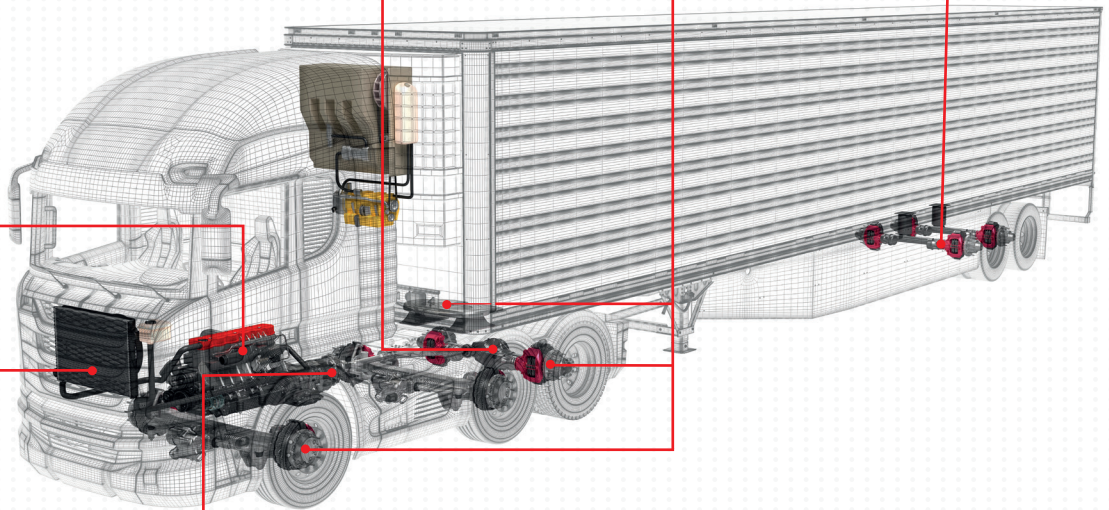

COOLANT SYSTEM

XTAR SI-OAT 50% SUPER COOLANT
CEPSA SI-OAT 50% SUPER COOLANT
CEPSA SUPER COOLANT 50%
XTAR SUPER COOLANT HYBRID NF 50%.

TRANSMISSIONS (AUTOMATIC)

ATF 4000 S
ATF 3000 S
ATF 2000 S
ATF 70

TRANSMISSIONS (MANUAL)

TRANSMISIONES EP FE+LD 75W90
TRANSMISIONES Z5 FE+LD 75W80
TRANSMISIONES FE+LD 75W80
TRANSMISIONES MBT 75W80
TRANSMISIONES 80W90

DIFFERENTIALS AND AXLES

TRANSMISIONES EP FE+LD 75W90
TRANSMISIONES EP 80W90
TRANSMISIONES EP 90
TRANSMISIONES EP 85W140

TRANSMISSIONS (AUTOMATIC)

ATF 4000 S
ATF 3000 S
ATF 2000 S
ATF 70

COOLANT SYSTEM

XTAR SI-OAT 50% SUPER COOLANT
CEPSA SI-OAT 50% SUPER COOLANT
CEPSA SUPER COOLANT 50%
XTAR SUPER COOLANT HYBRID NF 50%

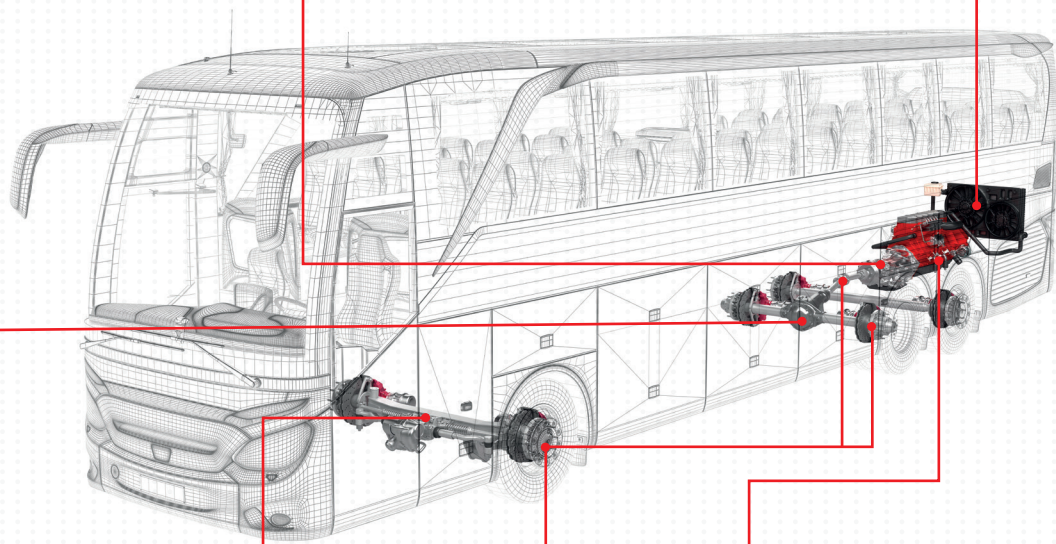

TRANSMISSIONS (MANUAL)

TRANSMISIONES EP FE+LD 75W90
TRANSMISIONES Z5 FE+LD 75W80
TRANSMISIONES FE+LD 75W80
TRANSMISIONES MBT 75W90
TRANSMISIONES 80W90

LUBRICATION POINTS

CEPSA ARGAL COMPLEX LITIO EP
CEPSA ARGAL LITIO 2 MOLY
CEPSA ARGAL LITIO EP-2

ENGINE'S SUMP

TRACTION PRO LS 5W30
TRACTION PRO LS 10W40
TRACTION ADVANCED LE 5W30
TRACTION ADVANCED LE 10W40
TRACTION ADVANCED LE 10W30
TRACTION ADVANCED LS 10W30
TRACTION ADVANCED LS 15W40
TRACTION ADVANCED LD 10W40
TRACTION MAX 10W40
TRACTION MAX 15W40

05 COOLANTS

CEPSA SUPER COOLANT 35%, 50% AND PURE

Long-life ethylene glycol-based coolant with a modern package of organic technology, low-toxicity environmentally-friendly corrosion inhibitors. Provides complete protection to all components of the cooling circuit of internal combustion engines. Free of amines, nitrites, phosphates, silicates and borates.
Color: fluorescent violet.



SUPER COOLANT PURE DILUTION	PROTECTION TEMPERATURE
35%	-19° C
40%	-27° C
50%	-37° C

QUALITY LEVELS		
UNE 26.361.88/1	SAE J-1034	ASTM D3306/D4656/D4985
JASO M325	NATO S-759	VW TL 774 D/F (G-12+)
MAZDA/MITSHUBISHI	MERCEDES 325.3	RENAULT 41-01-001S type D
MAN 324 type SNF	SCANIA	VOLVO 128 6083/002
CATERPILLAR	KOMATSU	JOHN DEERE JDMH5
MTU MTL 5048	DEUTZ-MWM	ULSTEIN-BERGEN
BS 6580	FORD WSS-M97B44-D/E	JENBACHER TA 1000-0201
OPEL/GM 6277M (+B040 1065)	TATA MOTORS	WÄRTSILÄ 32-9011

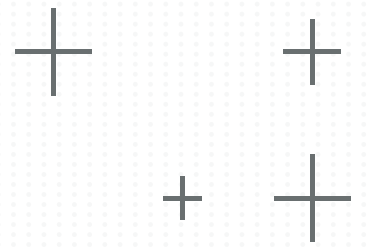

CEPSA SUPER COOLANT Si-OAT 50%

Antifreeze-coolant with a monoethylene glycol base and an exclusive package of corrosion inhibitors based on a combination of organic acid salts and silicates, thus preventing corrosion and protecting the environment. Suitable as a diluted coolant-antifreeze for direct use in the entire automotive and commercial vehicle market.

QUALITY LEVELS		
VW TL 774G (G12++)	MAN 324 Typ.Si-OAT	AS 2108-2004
ÖNORM V5123	BS 6580:2010	ASTM D 4985
CUNA NC 956-16	CUMMINS CES 14603	ASTM D 3306
JIS K 2234:2006	SCANIA TB 1451	ASTM D 6210
SANS 1251: 2005	SAEJ1034	SH 0521-1999
MB 326.5 (diluted)	PORSCHE (models since 1996)	

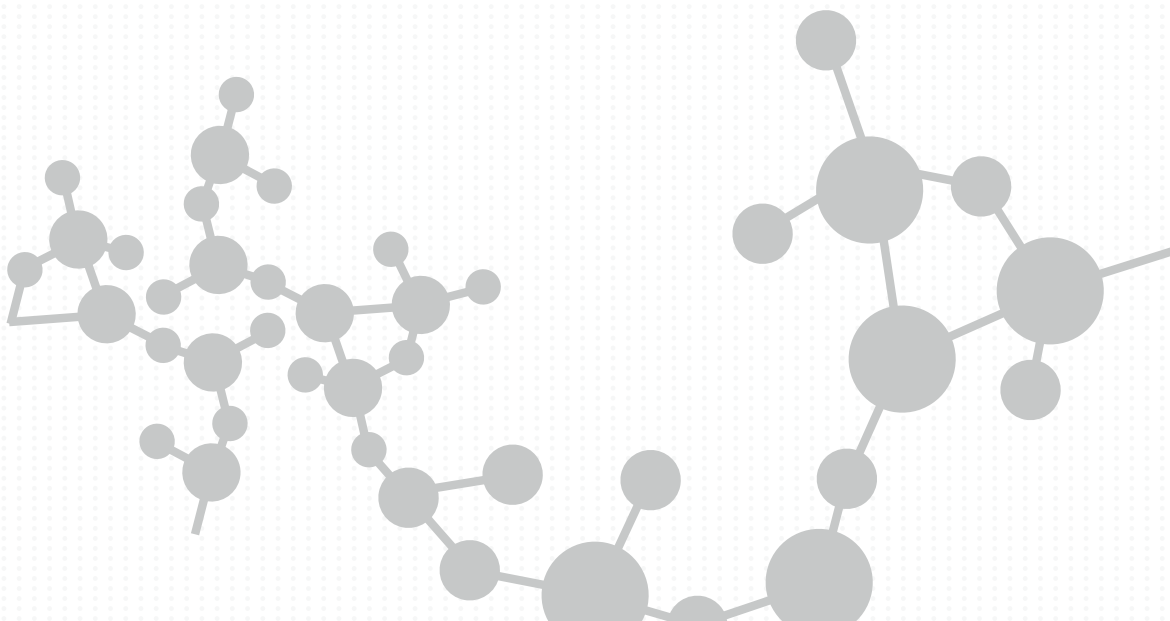

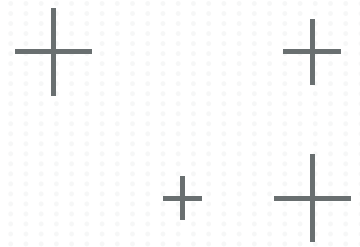

XTAR SI-OAT 50% SUPER COOLANT

Coolant based on new-generation “Lobrid” monoethylene glycol. It contains a unique corrosion inhibitor package based on a combination of organic acid salts and stabilized silicates that provide long-lasting protection to all components of the cooling circuit. Recommended for advanced technology engines, including EURO VI engines, where the protection of aluminum at high temperature is very important. Free from nitrites, amines, phosphates and borates.

Color: fluorescent pink.

XTAR SUPER COOLANT SI-OAT DILUTION	PROTECTION TEMPERATURE
33%	-19° C
40%	-27° C
50%	-37° C

APPROVALS				
VW TL 774 G (G12++)	MAN 324 Typ. Si-OAT	MB-Approval 325.5 (concentrated)	MB-Approval 325.6 (concentrated)	MB-Approval 326.5 (diluted)

QUALITY LEVELS				
AS 2108-2004	ASTM D 4985	ASTM D 3306	ASTM D 6210	SAEJ1034
ÖNORM V5123	CUNA NC 956-16	JIS K 2234:2006	SANS 1251: 2005	SH 0521-1999
BS 6580:2010	CUMMINS CES 14603	SCANIA TB 1451	PORSCHE (models since 1996)	

XTAR SUPER COOLANT HYBRID NF 50%

Coolant based on hybrid technology monoethylene glycol. It contains an exclusive blend of organic and inorganic corrosion inhibitors which provide long-lasting protection for all coolant system components of internal combustion engines.

APPROVALS	
MAN 324 Type NF	MB-Approval 325.0
GE Jenbacher TA-Nr. 1000-0201	DEUTZ DQC CA-14

QUALITY LEVELS				
VW TL 774-C	BMW N 600 69.0	SAAB 690 1599	SMART (MB)	MINI (BMW)
TESLA (Since 2013)	MTU MTL 5048	VAN HOOL	VOLVO CAR 1286083 Issue 002	ZASTAVA

SPECIFICATIONS

Standards

Manufacturers / OEMs

PRODUCT	ACEA	API	JASO*	MERCEDES BENZ	MAN	VOLVO RENAULT MAK	SCANIA	DETROIT DIESEL	CUMMINS	MTU	DEUTZ	CATERPILLAR*	DAF*	OTHERS*
TRACTION PRO LS 5W30	E6/E9/ E4/E7	CK-4	DH-2	228.52	3677/3775 3477/3271-1 ^a	VDS-4.5 RLD-3 EOS-4.5	LD-F-4	93K222*	20086*	3.1*	IV-18 LA*	ECF-3	Extended Drain	Iveco
TRACTION PRO LS 10W40	E6/E9 E4/E7	CJ-4	DH-2	228.51	3477/3575/3271-1 ^a	VDS-4 RLD-3 EO-0 PP	Low Ash	93K218	20081	3.1	IV-10 LA	ECF-3	Extended Drain	Iveco
TRACTION ADVANCED LE 5W30	E6/E9/E7	CK-4	DH-2	228.52	3677/3775 3477/3271-1 ^a	VDS-4.5 RLD-3 EOS-4.5	Low Ash	93K222*	20086*	3.1*	IV-18 LA*	ECF-3	Extended Drain	Iveco 18-180.4 TLS E9 Ford WSS-M2C213-A
TRACTION ADVANCED LE 10W40	E6/E9/E7	CJ-4	DH-2	228.51	3477/3271-1 ^a	VDS-4 RLD-3 EO-0 PP	Low Ash	93K218*	20081*	3.1*	IV-10 LA*	ECF-3		
TRACTION ADVANCED LE 10W30	E6/E9/E7	CK-4	DH-2	228.51	3677/3775 3477/3271-1 ^a	VDS-4 RLD-3 EO-0 PP		93K218*	20081*	3.1*	IV-10 LA*	ECF-3		
TRACTION ADVANCED LS 10W30	E9/E7	CK-4	DH-2	228.31	3775 3575 ^a	VDS-4.5 RLD-3 EOS-4.5		93K222*	20086*	2.1*	III-10 LA*	ECF-3		Ford WSS-M2C171-F1
TRACTION ADVANCED LS 15W40	E9/E7	CK-4	DH-2	228.31	3775 3575 ^a	VDS-4.5 RLD-3 EOS-4.5		93K222	20086	2.1*	III-10 LA*	ECF-3		Ford WSS-M2C171-F1
TRACTION ADVANCED LD 5W30	E4/E7			228.5	3277	VDS-3* RLD-2* EO-N*	LD-F-3		20077*	3*	IV-10*	ECF-3	Extended Drain	"Voith Retarder Class B MB 235.28"
TRACTION ADVANCED LD 10W40	E4/E7			228.5	3277	VDS-3 RLD-2 EO-N	LD-F-3		20072*	3	III-10		Extended Drain	
TRACTION ADVANCED 10W40	E4/E7	CJ-4		228.5	3377/3277	VDS-3 RLD-2 EO-N		93K215*	20078*	3*	IV-10*			Global DHD-1
TRACTION MAX 10W40	E7	CJ-4	DH-1	228.3	3275-1 ^a	VDS-3 RLD-2 EO-N		93K215*	20078*	2*	III-10*	ECF-2		Global DHD-1
TRACTION MAX 15W40	E7	CJ-4	DH-1	228.3	3275-1 ^a	VDS-3 RLD-2 EO-N		93K215	20078	2	III-10	ECF-2		Global DHD-1
TRACTION MAX 20W50		CH-4		228.3*	3275-1 ^a	VDS-2 ^a RD-2 ^a EO-N+ ^a			20077*	2*	II-05*	ECF-1a		
TRACTION 15W40	E2 ^a			228.1 ^a	271 ^a	VDS ^a EO-M ^a			20076*	1*		ECF-1a		
TRACTION 25W60														Allison C3 CCMC D2
TRACTION SAE 30-40-50-60														Allison C3 CCMC D2

without particulate filter (DPF)

with / without particulate filter (DPF)

*Complies with requirements
^aObsolete specification

06 AFTER-SALES

At Cepsa, one of the pillars of operational excellence that defines us is the **top quality technical service** we offer our customers.

We formulate, manufacture and market premium quality lubricants and are present throughout their life cycle. Our technical team **is deeply involved in product control and monitoring**. We provide **Cepsa's .OilMonitor** customers with **our own in-service oil analysis and diagnosis service**. To that end, we have our **Research Center**, with more than 12,000 m² and several specialized laboratories, among which the lubricants lab stands out.

As lubrication experts, we provide a variety of **customized technical consulting** services. In addition, **our team of specialized engineers** makes technical visits to prepare a detailed report where the causes of the detected problems are investigated and solutions are proposed. We also carry out **detailed lubrication charts and studies** for your industrial facilities or fleets of vehicles and ships.

To complete the range of services, the team of lubricant technical specialists offers **training courses, conferences and seminars** tailored to every need.





CEPSA Comercial Petróleo, S.A.U.

Paseo de la Castellana 259A.

28046 Madrid (Spain)

Tel. Customer Support

+34 91 337 75 55

lubricantes@cepsa.com

www.cepsa.es